

Ultrasonic Proximity Sensor & Module *(HG-P40 Series)*

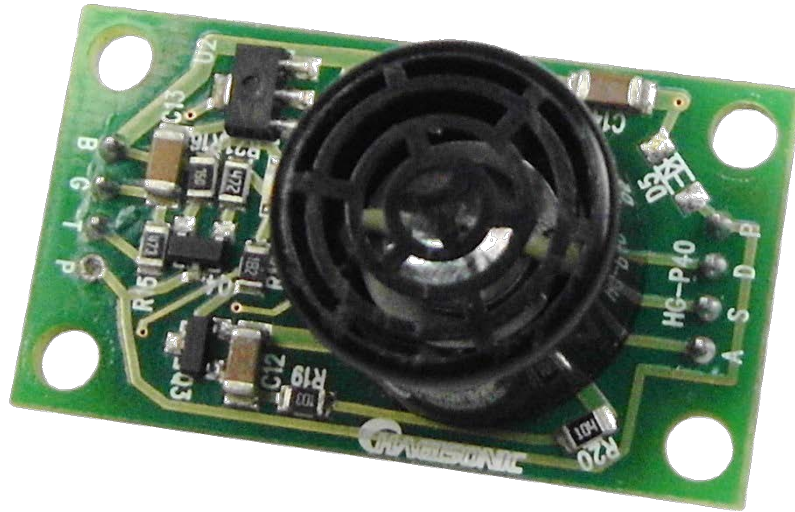

Leading Company of Advanced Sensors

HAGISONIC Co., Ltd.

Sensors & Application Systems for Robots, AGVs, Automobiles, Automations
and Energy-Saving Apparatus



Hagisonic Co., Ltd.

www.hagisonic.com / hagisonic@hagisonic.com

Tel : +82-42-936-7740 / Fax : +82-42-936-7742

Ultrasonic Proximity Sensor & Module

■ Model : HG-P40 Series

▣ Features

- Multi functional transceiver model
- Two types of transmit modes
(Free Run / External Trigger)
- Power Supply
(Low : 5V / High : 6~16V)
- 4 different output signals
(simultaneously)
 - Real time received and amplified ultrasonic wave
 - Real time TTL square signal
 - Distance pulse width signal
 - Detecting objects within the preset range(proximity)
- High performance ASIC Chip

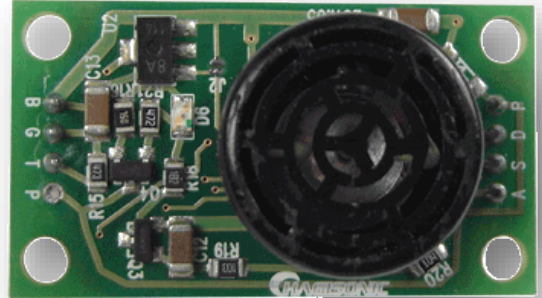

**HG-P40C
(Conventional)
Approx. 65° Directivity**

▣ Specification

Input DC	Low : 5V / High : 6~16V
Current consumption (when 12V is used)	- 12mA (Standby Mode) - 18mA (When an object is detected within the range) - 28mA (Proximity signal 10mA deducted)
Distance Range (at flat plate)	- 0.4~3m (when 5V is used) - 0.4~6m (when 12V±3V is used)
Size	Module : 20x36x20(mm) Sensor : Φ16

Ultrasonic Proximity Sensor & Module

■ Model : HG-P40 Series

▣ Description

- Using only a single transceiver sensor unit for transmit and receive signals.
- Convenient for distance measuring and object detection.
- Two types of transmit mode for convenience.
 - Free Run : With a power supply, sensor transmits trigger and burst signal itself – for basic application
 - External Trigger : External system(controller or processor circuit) controls the trigger signals – for advance application(distance measure)
- Two types of input power – Low(5V) for processor circuit usage and High(12V) for controllers.
- Four different output signal (simultaneously).
 - Real time ultrasonic wave amplified from actually received ultrasonic. (for sound pressure measuring)
 - Real time TTL level square signal(Square Wave) of detection signal. (for robots)
 - Distance pulse width signal which is proportional to the nearest object from the sensor. (for robots and distance measuring)
 - Proximity output signal(10mA current) within the preset range(0.5~4.5m) (for industrial use)
 - Preset range is adjustable from 0.5 to 4.5 m. (factory distance preset available for volume orders)
- High performance ASIC Chip for stable transmission and sensitive reception. (Max. approx. 4,000 times amplification)

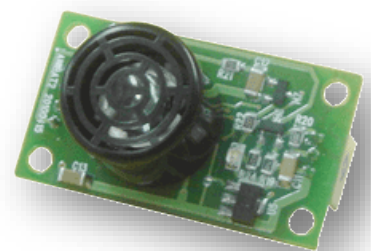

Ultrasonic Proximity Sensor & Module

■ Model : HG-P40 Series

▣ Part Name

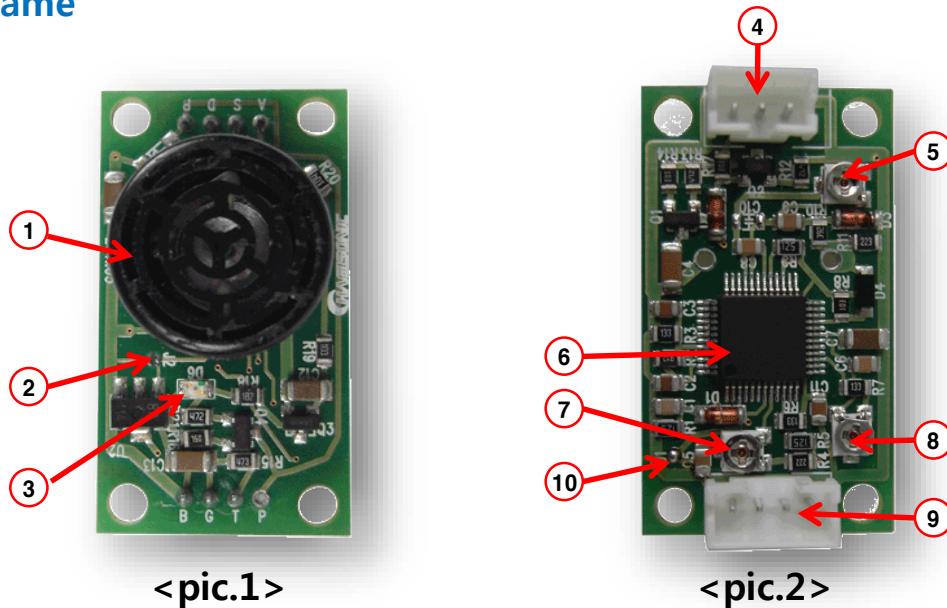

- ① **Ultrasonic sensor unit** : Ø16 Open type sensor has conventional directivities(appox. 65~75°).
- ② **Power selection PAD(J2)** : Low(5V) – with soldering, High(6~16V) – without soldering(at this condition, more than 6.5V is recommended).
- ③ **Proximity detection LED** : When object enters the preset range, red light is on and 10mA output signal is generated
- ④ **Output Terminal** : three different output is generated simultaneously.(Refer to Page 2 and 6)
- ⑤ **Receiver sensitivity adjusting VR** : Adjusting gain value of pre-amplifier from range of 0 to 4,000x.(Default factory option: 2,000X)
- ⑥ **ASIC Chip** : 48pin Chip with many functions. (Hagisonic Product)
- ⑦ **Distance range adjusting VR** : 0.5 to 4.5m range.
- ⑧ **Ultrasonic frequency adjusting** : Factory tuned for unit for the best performance(**Do not adjust this!**)
- ⑨ **Input Terminal** : Power, External Trigger input and proximity output signal(10mA current) terminal(Refer to Page 2 and 6)
- ⑩ **Transmit Mode selection PAD(J1)** :
 - Free Run Mode : With soldering; approx. 10 to 15 Burst per second is generated. (factory option : Soldered)
 - External Trigger Mode : Without soldering; External TTL level Pulse is needed for transmit.(1~100 per second available, but 10~30 per second recommended) (Pulse width : 0.5~1mS recommended)

Ultrasonic Proximity Sensor & Module

■ Model : HG-P40 Series

■ Timing Chart

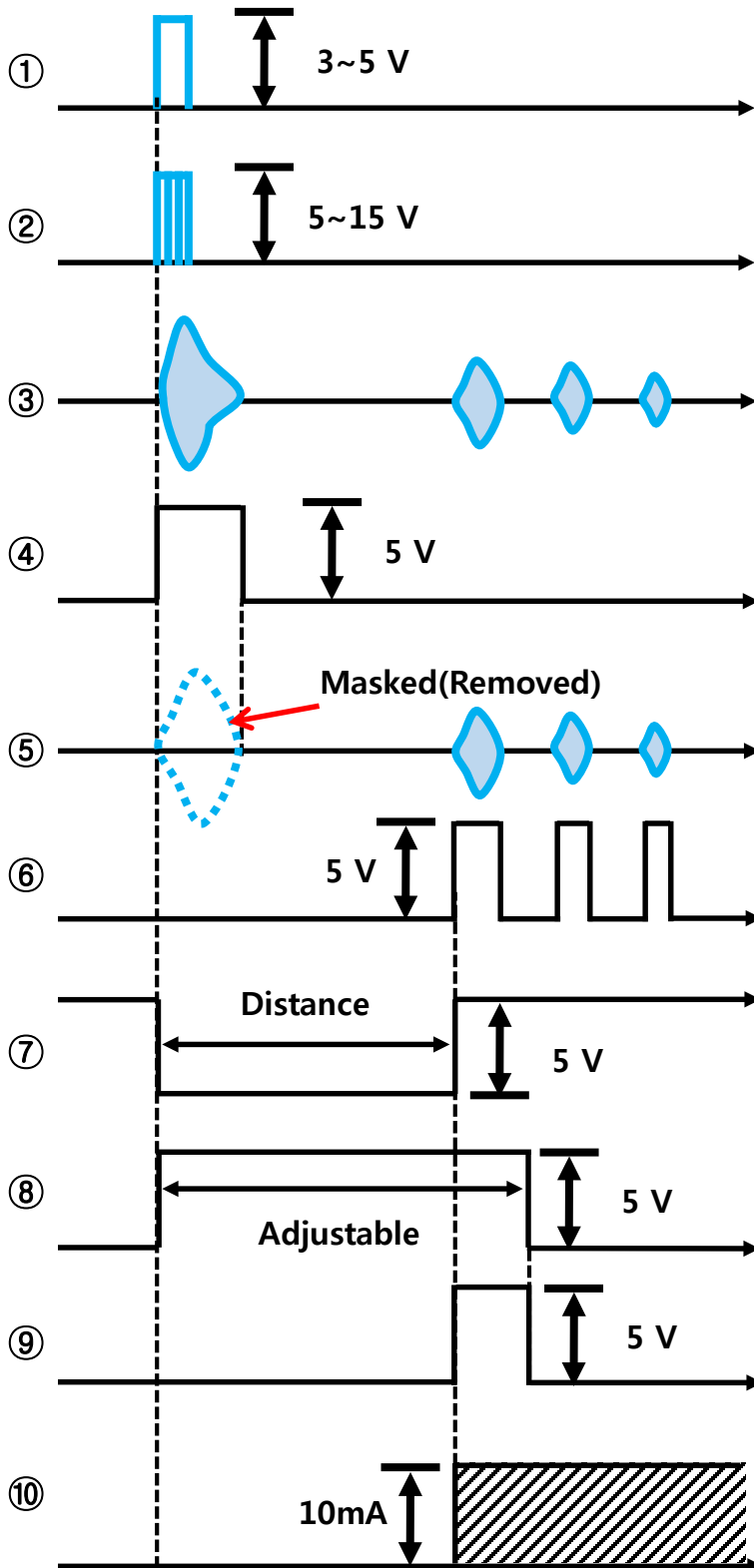

- Trigger Pulse : generated internally or externally
- Range measuring : 10~30 per second is recommended
- Normal use : 10 per second is recommended
- Ultrasonic burst signal from Trigger Pulse
- The vibration and amplified waveform according to transmitting and receiving of ultrasonic signal.
- Masking signal (Internal) to remove the first received internal crosstalk signal.
- Amplified signals only for the reflected (received) signals
- Converting received signal to digital form (signal)
- Time pulse proportional to the distance of wave that reflected first (proximal object)
- Preset limitation of distance window (Preset range).
- Filtering the signal in which only entered window limit
- Sample / Hold; converting the approach signal to continuous signal.

Ultrasonic Proximity Sensor & Module

■ Model : HG-P40 Series

▣ The principle of perceiving proximal object within 40cm range.

- ※ There will be no quantitative distance value. This is only for determining the object existence and non-existence

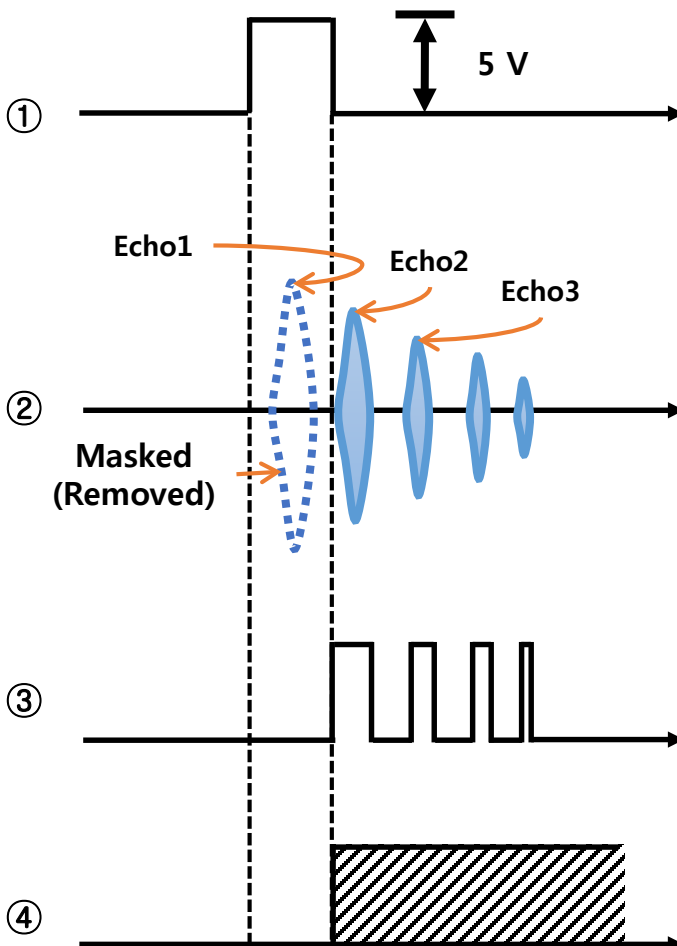
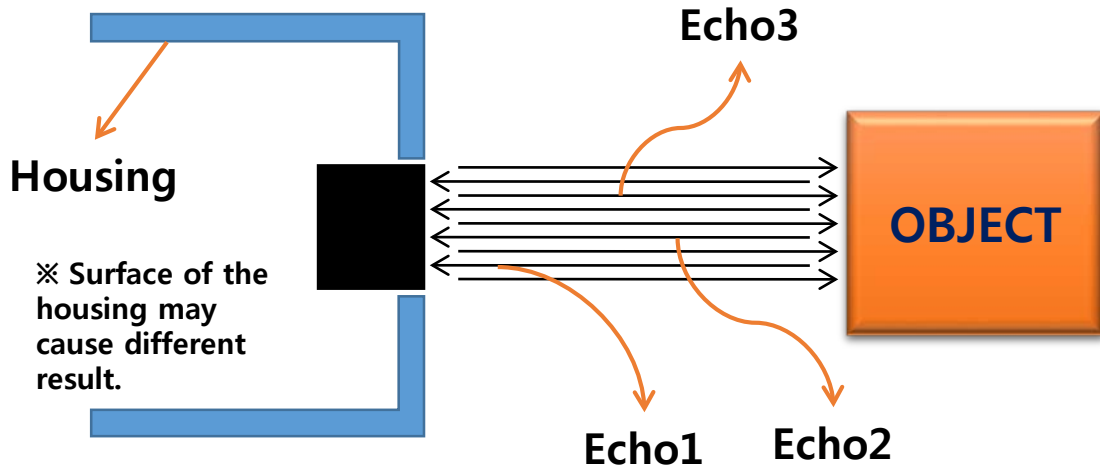

- Masking signal(Internal) to remove the first received interrupt signal.

- When the object is close, multi Echo(Flutter Echo) will be generated. Echo1(Sometimes to Echo2) may be masked(removed) since the signal moves so fast.

- The Echo signal perceived after Echo2 (Echo3) will be converted to digital format(signal).

- The Echo signal perceived after Echo2 (Echo3) is in the preset range that it is recognized as an 'Object.'

Ultrasonic Proximity Sensor & Module

■ Model : HG-P40 Series

■ Input / Output Terminal Configuration

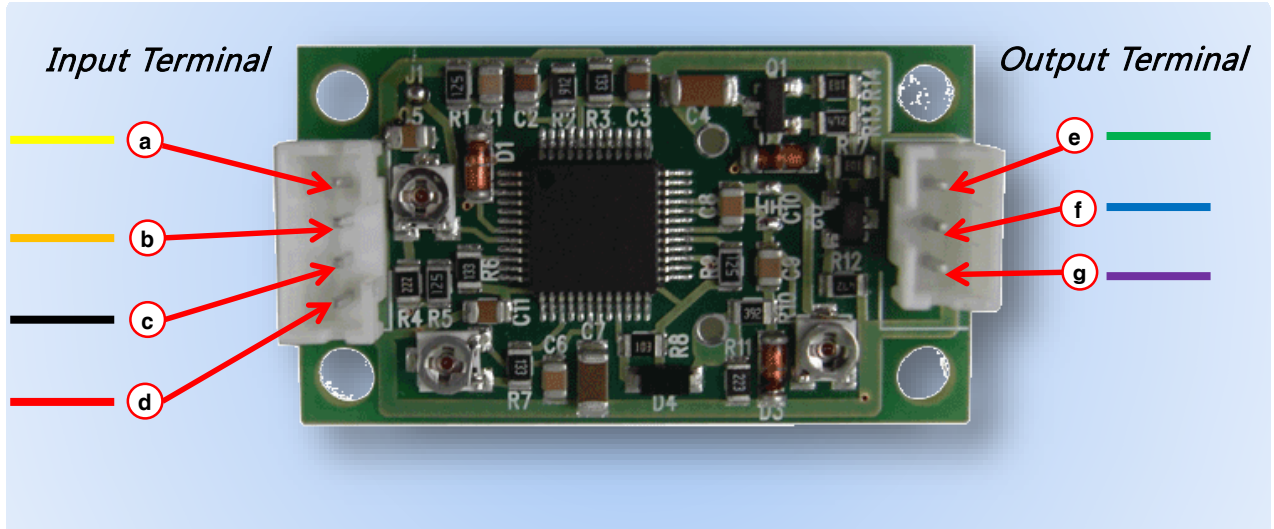

■ Terminal Configuration

- Ⓐ Output signal within the preset(distance) range (#⑩ wave from the Timing Chart(Page 5)) (Yellow)
- Ⓑ External Trigger / Monitor Terminal (Orange)
 - Signal input terminal for External Trigger Mode (0.5~1mS TTL recommended)
 - Monitor terminal for Free Run Mode to confirm the Trigger Timing. Internal trigger is generated.
- Ⓒ GND (Black)
- Ⓓ +Power : 5V~16V range input (Red)
- Ⓔ Real time ultrasonic amplified wave output (#⑤ wave from the Timing Chart(Page 5)) (Green)
- Ⓕ The wave converted similar to digit format. (#⑥ wave from the Timing Chart(Page 5)) (Blue)
- Ⓖ Pulse wave proportional to distance to the nearest object(The first detected object) (Violet) (#⑦ wave from the Timing Chart(Page 5))